

# Data sheet

## Video recorder LINAX A315



### Function and system design

Measuring principle	<p>Electronic acquisition, display, recording, analysis, remote transmission and archiving of analog and digital input signals.</p> <p>The device is intended for installation in a panel or cabinet. There is also the option of operating it in a desktop housing or field housing.</p>
Measuring system	<p>Multichannel data recording system with multicolored TFT display (145 mm / 5.7" screen size), galvanically isolated universal inputs (U, I, TC, RTD, pulse, frequency), digital inputs, transmitter power supply, limit relay, communication interfaces (USB, Ethernet, optional RS232/485), optionally available with Modbus protocol, 128 MB internal memory, external SD card and USB stick. An Essential Version of the reporting software is included for SQL-supported data analysis at the PC.</p> <p><b>i</b> The number of inputs available in the basic device can be individually increased using a maximum of 3 plug-in cards. The device supplies power directly to connected two-wire transmitters. The device is configured and operated via the navigator (jog/shuttle dial), via the integrated web server and a PC, or via an external keyboard. Online help facilitates local operation.</p>
Reliability	<p><b>Dependability</b></p> <p>Depending on the device version, the MTBF is between 52 years and 24 years (calculated based on SN29500 standard at 40°C)</p> <p><b>Serviceability</b></p> <p>Battery-backed time and data memory. It is advisable to have the backup battery replaced by a service technician after 10 years.</p> <p><b>Standard diagnostic functions as per Namur NE 107</b></p> <p>The diagnostic code is made up of the error category as per Namur NE 107 and the message number.</p> <ul style="list-style-type: none"> <li>■ Cable open circuit, short-circuit</li> <li>■ Incorrect wiring</li> <li>■ Internal device errors</li> <li>■ Overrange/underrange detection</li> <li>■ Ambient temperature out-of-range detection</li> </ul> <p><b>Device error/alarm relay</b></p> <p>One relay can be used as an alarm relay. If the device detects a system error (e.g. hardware defect) or a malfunction (e.g. cable open circuit), the selected output/relay switches.</p> <p>This "alarm relay" switches if "F"-type errors occur (F = failure), i.e. "M"-type errors (M= Maintenance required) do not switch the alarm relay.</p> <p><b>Safety</b></p> <p>The tamper-proof recorded data are saved and can be transferred to an external SQL database for archiving in a way that prevents subsequent manipulation.</p>

# Data sheet

## Video recorder LINAX A315

### Input

Measured variables

#### Number of analog universal inputs

Standard version without universal inputs. Optional input cards (slot 1-3) with 4 universal inputs (4/8/12) each.

#### Number of digital inputs

6 digital inputs

#### Number of mathematics channels

4 mathematics channels (optional). Mathematics functions can be freely edited via a formula editor.

#### Number of limit values

30 limit values (individual channel assignment)

#### Function of analog universal inputs

You are free to choose between the following measured variables for each universal input: U, I, RTD, TC, pulse input or frequency input.

#### Calculated values

The values of the universal inputs can be used to perform calculations in the mathematics channels.

Measuring range of analog universal inputs

According to IEC 60873-1: An additional display error of  $\pm 1$  digit is permitted for every measured value.

Measuring ranges which can be selected per universal input:

Measured variable	Measuring range	Maximum measured error of measuring range (oMR), RTD temperature drift	Input impedance
Current (I)	0 to 20 mA; 0 to 20 mA quadratic 0 to 5 mA 4 to 20 mA; 4 to 20 mA quadratic -20 to 20 mA Overrange: up to 22 mA or -22 mA	$\pm 0.1\%$ oMR	Load: 50 Ohm $\pm 1$ Ohm
Voltage (U) >1 V	0 to 10 V; 0 to 10 V quadratic 0 to 5 V 1 to 5 V; 1 to 5 V quadratic $\pm 10$ V $\pm 30$ V	$\pm 0.1\%$ oMR	$\geq 1$ MOhm
Voltage (U) $\leq 1$ V	0 to 1 V; 0 to 1 V quadratic $\pm 1$ V $\pm 150$ mV	$\pm 0.1\%$ oMR	$\geq 2.5$ MOhm
Resistance thermometer (RTD)	Pt100: -200 to 850 °C (-328 to 1562 °F) (IEC751, GOST) Pt100: -200 to 510 °C (-328 to 950 °F) (JIS1604-1984) Pt500: -200 to 500 °C (-328 to 932 °F) (IEC751) Pt500: -200 to 510 °C (-328 to 950 °F) (JIS1604-1984) Pt1000: -200 to 250 °C (-328 to 482 °F) (IEC751) Pt1000: -200 to 510 °C (-328 to 950 °F) (JIS1604-1984)	4-wire: $\pm 0.1\%$ oMR 3-wire: $\pm (0.1\%$ oMR + 0.8 K) 2-wire: $\pm (0.1\%$ oMR + 1.5 K) Temperature drift: $\pm 0.01\%/K$ oMR	
	Cu100: -50 to 200 °C (-58 to 392 °F) (GOST) Cu50: -50 to 200 °C (-58 to 392 °F) (GOST, $\alpha = 4260$ ppm/K) Cu50: -175 to 200 °C (-347 to 392 °F) (GOST, $\alpha = 4280$ ppm/K) Pt50: -185 to 1100 °C (-365 to 2012 °F) (GOST)	4-wire: $\pm 0.2\%$ oMR 3-wire: $\pm (0.2\%$ oMR + 0.8 K) 2-wire: $\pm (0.2\%$ oMR + 1.5 K) Temperature drift: $\pm 0.02\%/K$ oMR	

# Data sheet

## Video recorder LINUX A315

Measured variable	Measuring range	Maximum measured error of measuring range (oMR), RTD temperature drift	Input impedance
	Cu53: -50 to 180 °C (-58 to 356 °F) (GOST, $\alpha = 4280$ ppm/K) Pt46: -200 to 650 °C (-328 to 1202 °F) (GOST)	4-wire: $\pm 0.3\%$ oMR 3-wire: $\pm(0.3\% \text{ oMR} + 0.8 \text{ K})$ 2-wire: $\pm(0.3\% \text{ oMR} + 1.5 \text{ K})$ Temperature drift: $\pm 0.01\%/K$ oMR	
Thermocouples (TC)	Type J (Fe-CuNi): -210 to 1200 °C (-346 to 2192 °F) (IEC581-1) Type K (NiCr-Ni): -270 to 1300 °C (-454 to 2372 °F) (IEC581-1) Type T (Cu-CuNi): -270 to 400 °C (-454 to 752 °F) (IEC581-1) Type N (NiCrSi-NiSi): -270 to 1300 °C (-454 to 2372 °F) (IEC581-1) Type L (Fe-CuNi): -200 to 900 °C (-328 to 1652 °F) (DIN43710) Type L (Fe-CuNi): -200 to 659 °C (-328 to 1218.2 °F) (GOST)	$\pm 0.1\%$ oMR from -100 °C (-148 °F) $\pm 0.1\%$ oMR from -130 °C (-202 °F) $\pm 0.1\%$ oMR from -200 °C (-328 °F) $\pm 0.1\%$ oMR from -100 °C (-148 °F) $\pm 0.1\%$ oMR from -100 °C (-148 °F) $\pm 0.1\%$ oMR from -100 °C (-148 °F)	$\geq 1 \text{ MOhm}$
	Type D (W3Re-W25Re): 0 to 2315 °C (32 to 4199 °F) (ASTME988) Type C (W5Re-W26Re): 0 to 2315 °C (32 to 4199 °F) (ASTME988) Type B (Pt30Rh-Pt6Rh): 40 to 1820 °C (104 to 3308 °F) (IEC581-1) Type S (Pt10Rh-Pt): -50 to 1768 °C (-58 to 3214 °F) (IEC581-1) Type R (Pt13Rh-Pt): -50 to 1768 °C (-58 to 3214 °F) (IEC581-1) Type A (W5Re-W20Re): 0 to 2500 °C (32 to 4532 °F) (ASTME988)	$\pm 0.15\%$ oMR from 500 °C (932 °F) $\pm 0.15\%$ oMR from 500 °C (932 °F) $\pm 0.15\%$ oMR from 600 °C (1112 °F) $\pm 0.15\%$ oMR from 100 °C (212 °F) $\pm 0.15\%$ oMR from 100 °C (212 °F) $\pm 0.15\%$ oMR from 500 °C (932 °F)	$\geq 1 \text{ MOhm}$
Pulse input (I)	Min. pulse length 40 $\mu\text{s}$ , max. 12.5 kHz; 0 to 7 mA = LOW; 13 to 20 mA = HIGH	$\pm 0.02\%$ @ $f < 100 \text{ Hz}$ $\pm 0.01\%$ @ $f \geq 100 \text{ Hz}$ Temperature drift: 0.01% of measured value over the entire temperature range	Load: 50 Ohm $\pm 1$ Ohm
Frequency input (I)	0 to 10 kHz, overrange: up to 12.5 kHz; 0 to 7 mA = LOW; 13 to 20 mA = HIGH		

### Maximum load of inputs

Limit values for input voltage and current as well as cable open circuit detection/line influence/temperature compensation:

Measured variable	Limit values (steady-state, without destroying input)	Cable open circuit detection/line influence/temperature compensation
Current (I)	Maximum permitted input voltage: 2.5 V Maximum permitted input current: 50 mA	4 to 20 mA range with disengageable cable open circuit monitoring to NAMUR NE43. The following error ranges apply when NE43 is switched on: $\leq 3.8 \text{ mA}$ : underrange $\geq 20.5 \text{ mA}$ : overrange $\leq 3.6 \text{ mA}$ or $\geq 21.0 \text{ mA}$ : open circuit (display shows: - - - -)
Pulse, frequency (I)	Maximum permitted input voltage: 2.5 V Maximum permitted input current: 50 mA	No cable open circuit monitoring
Voltage (U) >1 V	Maximum permitted input voltage: 35 V	1 to 5 V range with disengageable cable open circuit monitoring: $< 0.8 \text{ V}$ or $> 5.2 \text{ V}$ : cable open circuit (display shows: - - - -)
Voltage (U) $\leq 1 \text{ V}$	Maximum permitted input voltage: 24 V	
Resistance thermometer (RTD)	Measuring current: $\leq 1 \text{ mA}$	Maximum barrier resistance (or line resistance): 4-wire: max. 200 Ohm; 3-wire: max. 40 Ohm Maximum influence of barrier resistance (or line resistance) for Pt100, Pt500 and Pt1000: 4-wire: 2 ppm/Ohm, 3-wire: 20 ppm/Ohm Maximum influence of barrier resistance (or line resistance) for Pt46, Pt50, Cu50, Cu53, Cu100 and Cu500: 4-wire: 6 ppm/Ohm, 3-wire: 60 ppm/Ohm Cable open circuit monitoring if any connection is interrupted.
Thermocouples (TC)	Maximum permitted input voltage: 24 V	Cable open circuit detection from 50 kOhm Influence of wire resistance in event of open circuit detection: $< 0.001\%/Ohm$ Error, internal temperature compensation: $\leq 2 \text{ K}$

### Scan rate

Current/voltage/pulse/frequency input: 100 ms per channel

Thermocouples and resistance temperature detector: 1 s per channel

# Data sheet

## Video recorder LINAX A315

### Data storage / save cycle

Selectable save cycle. Choose from: 1s / 2s / 3s / 4s / 5s / 10s / 15s / 20s / 30s / 1min / 2min / 3min / 4min / 5min / 10min / 15min / 30min / 1h

### Converter resolution

24 bit

### Totalization

The interim, daily, monthly and yearly value and the total value can be determined (13-digit, 64 bit).

### Analysis

Recording of quantity/operating time (standard function), also a min/max/median analysis within the set time frame.

### Digital inputs

<b>Input level</b>	To IEC 61131-2: logical "0" (corresponds to -3 to +5 V), activation with logical "1" (corresponds to +12 to +30 V)
<b>Input frequency</b>	Max. 25 Hz
<b>Pulse length</b>	Min. 20 ms
<b>Input current</b>	Max. 2 mA
<b>Input voltage</b>	Max. 30 V

### Selectable functions

- Functions of the digital input: control input, ON/OFF message, pulse counter (13-digit, 64 bit), operating time, message+operating time, quantity from time, Modbus slave.
- Functions of the control input: start recording, screen saver on, lock setup, time synchronization, limit monitoring on/off, lock keyboard/navigator, start/stop analysis.

## Output

### Auxiliary voltage output

The auxiliary voltage output can be used for loop power supply or to control the digital inputs. The auxiliary voltage is short-circuit proof and galvanically isolated.

<b>Output voltage</b>	24 V <sub>DC</sub> ±15%
<b>Output current</b>	Max. 250 mA

### Galvanic isolation

*All inputs and outputs are galvanically isolated from each other and designed for the following testing voltages:*

	Relay	Digital in	Analog in	Ethernet	RS232/RS485	USB	Auxiliary voltage output
Relay	500 V <sub>DC</sub>	2 kV <sub>DC</sub>	2 kV <sub>DC</sub>	2 kV <sub>DC</sub>	2 kV <sub>DC</sub>	2 kV <sub>DC</sub>	2 kV <sub>DC</sub>
Digital in	2 kV <sub>DC</sub>	Galvanically connected	500 V <sub>DC</sub>	500 V <sub>DC</sub>	500 V <sub>DC</sub>	500 V <sub>DC</sub>	500 V <sub>DC</sub>
Analog in	2 kV <sub>DC</sub>	500 V <sub>DC</sub>	500 V <sub>DC</sub>	500 V <sub>DC</sub>	500 V <sub>DC</sub>	500 V <sub>DC</sub>	500 V <sub>DC</sub>
Ethernet	2 kV <sub>DC</sub>	500 V <sub>DC</sub>	500 V <sub>DC</sub>	-	500 V <sub>DC</sub>	500 V <sub>DC</sub>	500 V <sub>DC</sub>

# Data sheet

## Video recorder LINAX A315

	Relay	Digital in	Analog in	Ethernet	RS232/RS485	USB	Auxiliary voltage output
RS232/RS485	2 kV <sub>DC</sub>	500 V <sub>DC</sub>	500 V <sub>DC</sub>	500 V <sub>DC</sub>	-	500 V <sub>DC</sub>	500 V <sub>DC</sub>
USB	2 kV <sub>DC</sub>	500 V <sub>DC</sub>	500 V <sub>DC</sub>	500 V <sub>DC</sub>	500 V <sub>DC</sub>	Galvanically connected	500 V <sub>DC</sub>
Auxiliary voltage output	2 kV <sub>DC</sub>	500 V <sub>DC</sub>	500 V <sub>DC</sub>	500 V <sub>DC</sub>	500 V <sub>DC</sub>	500 V <sub>DC</sub>	-

### Relay outputs

A mix of low voltage (230 V) and safety extra low voltage (SELV circuits) is not permitted at the connections of the relay contacts.

#### Alarm relay

1 alarm relay with changeover contact.

#### Standard relay

5 relays with NO contact, e.g. for limit value messages (can be configured as NC contact).

#### Relay switching capacity

- Max. switching capacity: 3 A@ 30 V DC
- Max. switching capacity: 3 A@ 250 V AC
- Min. switching load: 300 mW

#### Switching cycles

>10<sup>5</sup>

### Cable specification

#### Cable specification, spring terminals

All connections to the rear of the unit are designed as screw or spring terminal blocks with reverse polarity protection. This makes the connection very quick and easy. The spring terminals are unlocked with a slotted screwdriver (size 0).

Please note the following when connecting:

- Wire cross-section, auxiliary voltage output, digital I/O and analog I/O: max. 1.5 mm<sup>2</sup> (14 AWG) (spring terminals)
- Wire cross-section, power supply: max. 2.5 mm<sup>2</sup> (13 AWG) (screw terminals)
- Wire cross-section, relays: max. 2.5 mm<sup>2</sup> (13 AWG) (spring terminals)
- Stripping length: 10 mm (0.39 in)

 No ferrules have to be used when connecting flexible wires to spring terminals.

#### Cable type

 Use shielded signal lines for interfaces!

# Data sheet

## Video recorder LINAX A315

### Power supply

Terminal assignment

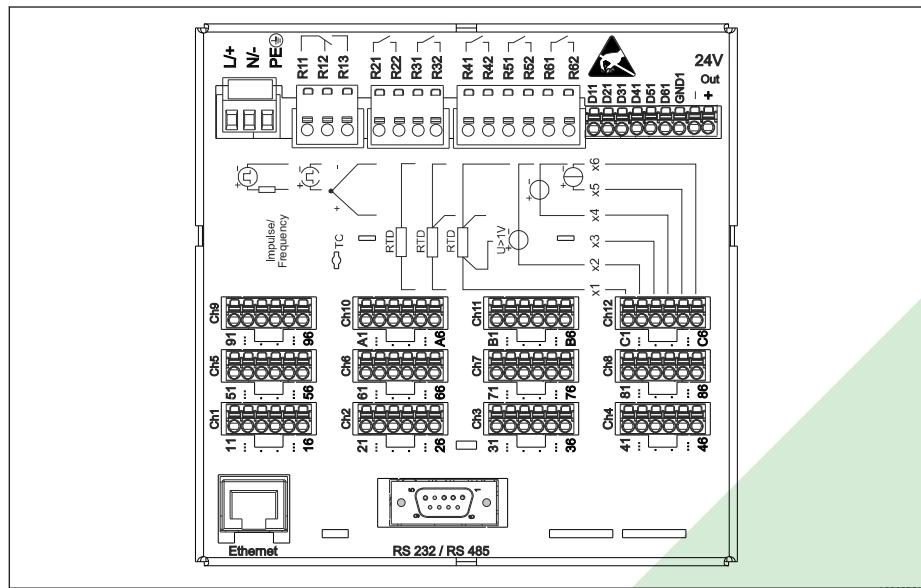

10 Terminals on back of device

Supply voltage

- Extra-low voltage power supply unit  $\pm 24$  V AC/DC (-10% / +15%) 50/60Hz
- Low voltage power supply unit 100 to 230 V AC ( $\pm 10\%$ ) 50/60Hz

**i** An overload protection element (rated current  $\leq 10$  A) is required for the power cable.

Power consumption

- 100 to 230 V: max. 35 VA
- 24 V: max. 24 VA

The power actually consumed depends on the individual operating state and the device version (LPS, USB, brightness of screen, number of channels, etc). The active power here is approx. 3 W to 20 W.

Power supply failure

Battery-backed time and data memory. The device starts automatically following a power failure.

Electrical connection

Details about the electrical connection: ([→](#) 11)

Device plug

- Panel-mounted device: connected to mains via plug-in screw terminals with reverse polarity protection
- Desktop version (option): connected to mains via regular-temperature C13/C14 coupler

Overvoltage protection

To avoid high-energy transients on long signal cables, connect a suitable surge arrester upstream (e.g. E+H HAW562).

# Data sheet

## Video recorder LINAX A315

Interface, communication  
connection data

### USB ports (standard):

*1 x USB port type A (host)*

A USB 2.0 connection is available on a shielded USB A socket at the front of the device. A USB stick, for example, can be connected to this interface as a storage medium. An external keyboard or USB hub may also be connected.

*1 x USB port type B (function)*

A USB 2.0 connection is available on a shielded USB B socket at the front of the device. This can be used to connect the device for communication with a laptop, for example.

### Ethernet interface (standard):

Ethernet interface on back, 10/100 Base-T, plug type RJ45. The Ethernet interface can be used to integrate the device via a hub or switch into a PC network (TCP/ IP Ethernet). A standard patch cable (e.g. CAT5E) can be used for the connection. Using DHCP, the device can be fully integrated into an existing network without the need for additional configuration. The device can be accessed from every PC in the network. Normally only the automatic assignment of the IP address must be configured at the client. When the device is started, it can automatically retrieve the IP address, subnet mask and gateway from a DHCP server. If a DHCP is not used, these settings must be made directly in the device (depends on the network to which the device is to be connected). Two Ethernet function LEDs are located on the rear of the device.

### Serial RS232/RS485 interface (option):

A combined RS232/RS485 connection is available on a shielded SUB D9 socket at the rear of the device. This can be used for data or program transfer and to connect a modem. For communication via modem, we recommend an industrial modem with a watchdog function.

- The following baud rates are supported: 9600, 19200, 38400, 57600, 115200
- Max. line length with shielded cable: 2 m (6.6 ft) (RS232), or 1000 m (3281 ft) (RS485)

 Only one interface can be used at any one time (RS232 or RS485).

## Performance characteristics

Response time

Input	Output	Time [ms]
Current, voltage, pulse	Relay	≤ 550
RTD	Relay	≤ 1150
TC <sup>1)</sup>	Relay	≤ 1550
Cable open circuit detection, current input	Relay	≤ 1150
Cable open circuit detection, RTD, TC	Relay	≤ 5000
Digital input	Relay	≤ 350
HART input	Relay	Non-deterministic

1) If internal measuring point temperature compensation is used, otherwise values as for voltage

Reference operating  
conditions

Reference temperature	25 °C (77 °F) ±5 K
Warm-up period	120 min.
Humidity	20 to 60 % rel. humidity

# Data sheet

## Video recorder LINAX A315

Hysteresis	Can be configured for limit values in the setup
Long-term drift	To IEC 61298-2: max. $\pm 0.1\%$ /year (of measuring range)

### Installation

Mounting location and installation dimensions	The device is designed for use in a panel in non-hazardous areas.
---	---

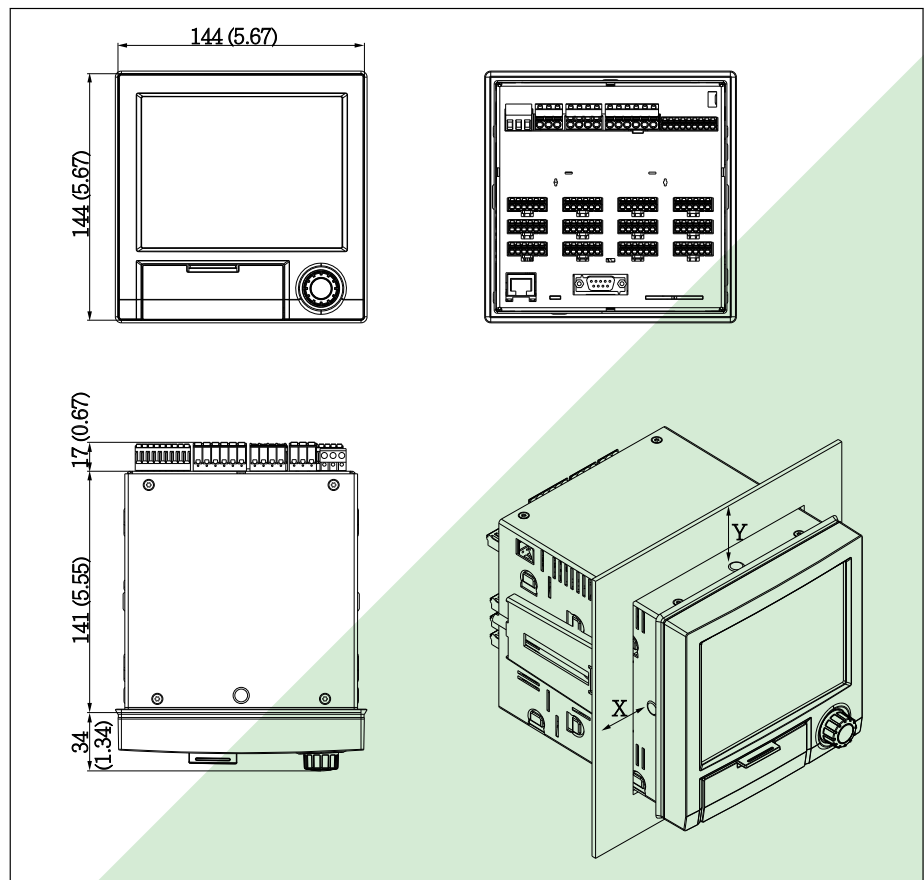

11 Panel mounting and dimensions in mm (in)

Please observe the installation depth of approx. 158 mm (6.22 in) for the device incl. terminals and fastening clips.

- Panel cutout: 138 to 139 mm (5.43 to 5.47 in) x 138 to 139 mm (5.43 to 5.47 in)
- Panel strength: 2 to 40 mm (0.08 to 1.58 in)
- Angle of vision: from the midpoint axis of the display, 75° to the left and right, 65° above and below.
- A minimum distance of 15 mm (0.59 in) mm (inch) between the devices must be observed if aligning the devices in the Y-direction (vertically above one another). A minimum distance of 10 mm (0.39 in) mm (inch) between the devices must be observed if aligning the devices in the X-direction (horizontally beside one another).
- Securing to DIN 43 834



# Data sheet

## Video recorder LINAX A315

Field housing assembly and design (optional) As an option, the device can be ordered ready-mounted in a field housing with IP65.  
Dimensions (B x H x D) approx.: 320 mm (12.6 in) x 320 mm (12.6 in) x 254 mm (10 in)

Desktop housing assembly and design (optional) As an option, the device can be ordered ready-mounted in a desktop housing.  
Dimensions (B x H x D) approx.: 293 mm (11.5 in) x 188 mm (7.4 in) x 211 mm (8.3 in)  
(dimensions with bracket, feet and installed device)

### Environment

Ambient temperature range -10 to +50 °C (14 to 122 °F)

Storage temperature -20 to +60 °C (-4 to +140 °F)

Humidity 5 to 85 %, non-condensing

Climate class To IEC 60654-1: Class B2

Altitude < 2 000 m (6 561 ft) over MSL

Degree of protection

<b>Front</b>	IP65 / NEMA 4
<b>Rear</b>	IP20

Electromagnetic compatibility

- Interference immunity: To IEC 61326 (industrial environment) / NAMUR NE 21
- Interference emissions: To IEC 61326, Class A

### Mechanical construction

Design, dimensions Information about design and dimensions (→  61)

Weight

- Panel-mounted device with maximum configuration: approx. 2.2 kg (4.85 lbs)
- Desktop housing (excluding device): approx. 2.3 kg (5 lbs)
- Field housing (excluding device): approx. 4 kg (8.8 lbs)

Materials

Front frame	Zinc die cast GD-Z410, powder-coated
Sight glass	Transparent Makrolon plastic (FR clear 099) UL94-V2
Flap; jog/shuttle dial	Plastic ABS UL94-V2
Mounting guide rail for PCBs; motherboard fixing unit; display retainer plate	Plastic PA6-GF15 UL94-V2
Seal to panel wall; seal to display; seal in flap; seal to navigator	Rubber EPDM 70 Shore A
Casing; rear panel	Galvanized sheet steel St 12 ZE

# Data sheet

## Video recorder LINAX A315

 All materials are silicone-free.

### Materials of desktop housing

- Housing half-panels: sheet steel, electrolytically plated (powder-coated)
- Side sections: aluminum extruded section (powder-coated)
- Section ends: colored polyamide

### Display and operating elements

#### Operating concept

The device can be operated directly onsite, or via remote configuration with the PC via interfaces and operating tools (web server, configuration software).

#### Integrated operating instructions

The unit's simple control system enables you to perform commissioning for many applications without the need for hardcopy operating instructions. The device has an integrated help function and displays operating instructions directly on screen if the navigator (jog/shuttle dial) is pressed for longer than 3 seconds.

#### Local operation

#### Operating elements

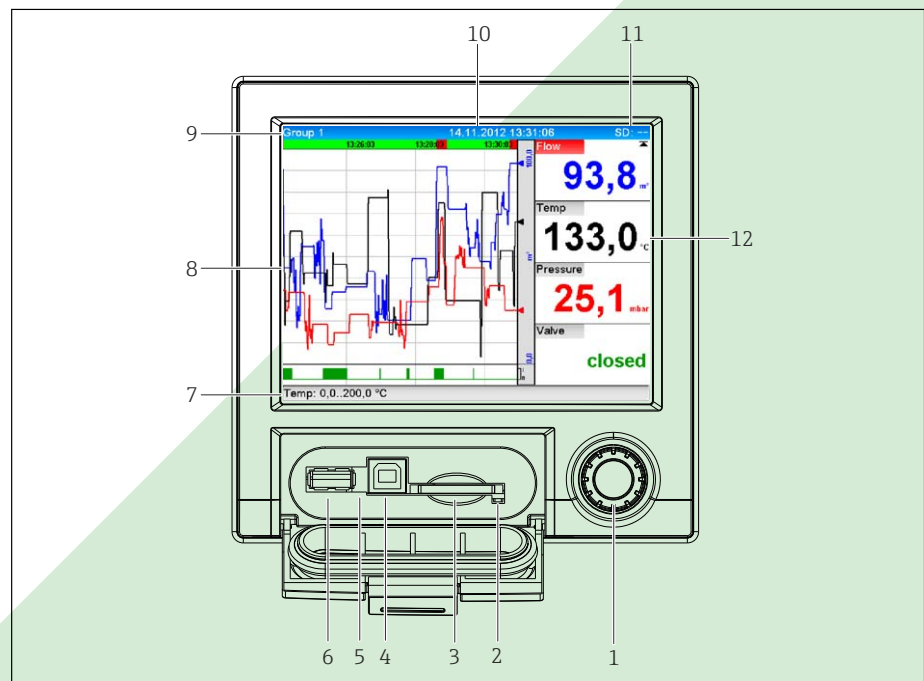

 12 Front of device with open flap

A0020602-EN

# Data sheet

## Video recorder LINAX A315

Item No.	Operating function (display mode = display of measured values) (Setup mode = operating in the Setup menu)
1	"Navigator": jog/shuttle dial for operating with additional press function. In Display mode: turn the dial to switch between the various signal groups. Press the dial to display the main menu. In Setup mode or in a selection menu: turn the dial anticlockwise to move the bar or the cursor upwards or counterclockwise, changes the parameter. Turning clockwise moves the bar or cursor down or clockwise, changes parameter.
2	LED at SD slot. Orange LED lit when the device writes to the SD card or reads it.
3	Slot for SD card
4	USB B socket "Function" e.g. to connect to PC or laptop
5	Green LED lit: Power supply present
6	USB A socket "Host" e.g. for USB memory stick or external keyboard
7	In Display mode: alternating status display (e.g. set zoom range) of the analog or digital inputs in the appropriate color of the channel. In Setup mode: different information can be displayed here depending on the display type.
8	In Display mode: window for measured value display (e.g. curve display). In Setup mode: display of operating menu
9	In Display mode: current group name, type of evaluation In Setup mode: name of the current operating item (dialog title)
10	In Display mode: displays current date/time In Setup mode: --
11	In Display mode: alternating display indicating the percentage space on the SD card or USB stick that has already been used. Status symbols are also displayed in alternation with the memory information. In Setup mode: the current "direct access" operating code is displayed
12	In Display mode: display of current measured values and the status in the event of an error/alarm condition. In the case of counters, the type of counter is displayed as a symbol.  If a measuring point has limit value status, the corresponding channel identifier is highlighted in red (quick detection of limit value violations). During a limit value violation and device operation, the acquisition of measured values continues uninterrupted.

### Languages

The following languages can be selected in the operating menu: German, English, Spanish, French, Italian, Dutch, Swedish, Polish, Portuguese, Czech, Russian, Japanese, Chinese (Traditional), Chinese (Simplified)

### Remote operation

#### Device access via operating tools

Device configuration and measured value retrieval can also be done via interfaces. The following operating tools are available for this purpose:

Operating tool	Functions	Access via
Analysis software, SQL database support (included in scope of delivery)	<ul style="list-style-type: none"> <li>▪ Export of saved data (measured values, analyses, event log)</li> <li>▪ Visualization and processing of saved data (measured values, analyses, event log)</li> <li>▪ Safe archiving of exported data in a SQL database</li> </ul>	RS232/RS485, USB, Ethernet
Web server (integrated into the device; access via browser)	<ul style="list-style-type: none"> <li>▪ Display of current and historical data and measured value curves via the web browser</li> <li>▪ Easy configuration without additional installed software</li> <li>▪ Remote access to device and diagnostic information</li> </ul>	Ethernet

# Data sheet

## Video recorder LINAX A315

OPC server (optional)	The following momentary values can be provided: <ul style="list-style-type: none"><li>▪ Analog channels</li><li>▪ Digital channels</li><li>▪ Mathematics</li><li>▪ Totalizer</li></ul>	RS232/RS485, USB, Ethernet
Configuration software (included in scope of supply)	<ul style="list-style-type: none"><li>▪ Device configuration</li><li>▪ Loading and saving device data (upload/download)</li><li>▪ Documentation of the measuring point</li></ul>	USB, Ethernet

### System integration

The device has (optional) fieldbus interfaces for exporting process values. Measured values and statuses can also be transmitted to the device via fieldbus. Depending on the bus system, alarms or faults occurring during data transmission are displayed (e.g. status byte). The process values are transferred in the same devices that are used for display at the device.

#### Ethernet

The following functions are implemented:

- Data communication with PC software (analysis software, configuration software, OPC server)
- Web server

#### Modbus RTU/TCP slave

The device can be connected to a Modbus system via RS485 or Ethernet interface. Up to 12 analog inputs and 6 digital inputs can be transmitted via Modbus and stored in the device.

## Certificates and approvals

### CE mark

#### Declaration of Conformity

The product meets the requirements of the harmonized European standards. As such, it complies with the legal specifications of the EC directives. The manufacturer confirms successful testing of the product by affixing to it the CE mark.

### Approvals

CSA GP  
UL-listed

### Other standards and guidelines

- IEC 60529:  
Degrees of protection provided by enclosures (IP code)
- IEC 61010-1: 2001 Cor 2003  
Safety requirements for electrical equipment for measurement, control and laboratory use

## Ordering information

### Scope of delivery

The scope of delivery of the device comprises:

- Device (with terminals, as per your order)
- 2 fastening clips
- USB cable
- Optional: Industrial grade SD card (card is located in the device).
- Analysis software on CD-ROM
- Configuration software on DVD
- Delivery note
- Multilanguage Brief Operating Instructions as hard copy
- Multilanguage Operating Instructions on CD-ROM

# CAMILLE BAUER

**Rely on us.**

Camille Bauer AG  
Aargauerstrasse 7  
CH-5610 Wohlen / Switzerland

Telefon: +41 56 618 21 11

Telefax: +41 56 618 21 21

info@camillebauer.com

www.camillebauer.com